



MANUAL LEKKER BIKES

**BAFANG
DISPLAY**



CONTACT

AUSTRALIA - NZ - SINGAPORE

phone:

1300 053 525 – Melbourne

0466 596 301 – Sydney

address:

23 Provost Street, North Melbourne, 3051, VIC,
Australia

415 Bourke Street, Surry Hills, 2010, NSW, Australia

email:

info.au@lekkerbikes.com

sydneystore@lekkerbikes.com

EUROPE & USA

phone: +31-681878491

address: Westerdijk 20A, 2451 VB Leimuiden,
Netherlands

email: info.eu@lekkerbikes.com

TABLE OF CONTENTS

CHAPTER 1 Display installation	3
CHAPTER 2 Display	5
CHAPTER 3 Key Definition	7
CHAPTER 4 Normal Operation	8
CHAPTER 5 Settings	15
CHAPTER 6 Error Code Definition	31
CHAPTER 7 General information	38

CHAPTER 1

Display installation

1. Remove the holding bracket from the display, and then **place** the display into **position** on the handlebar. (suitable for \varnothing 22.2mm handlebar).

2. Now place the **holding bracket** on the underside of the display and tighten it into position with **2 X M1.5*6 screws**. Torque requirement: **0.5N.m**.

3. Now **connect** the **Display connector** to the **EB-Bus** connector, ensuring both connectors are kept parallel when pushing firmly together.

IMAGES

Chapter 1

(From LEFT to RIGHT, images follow the order of instructions.)

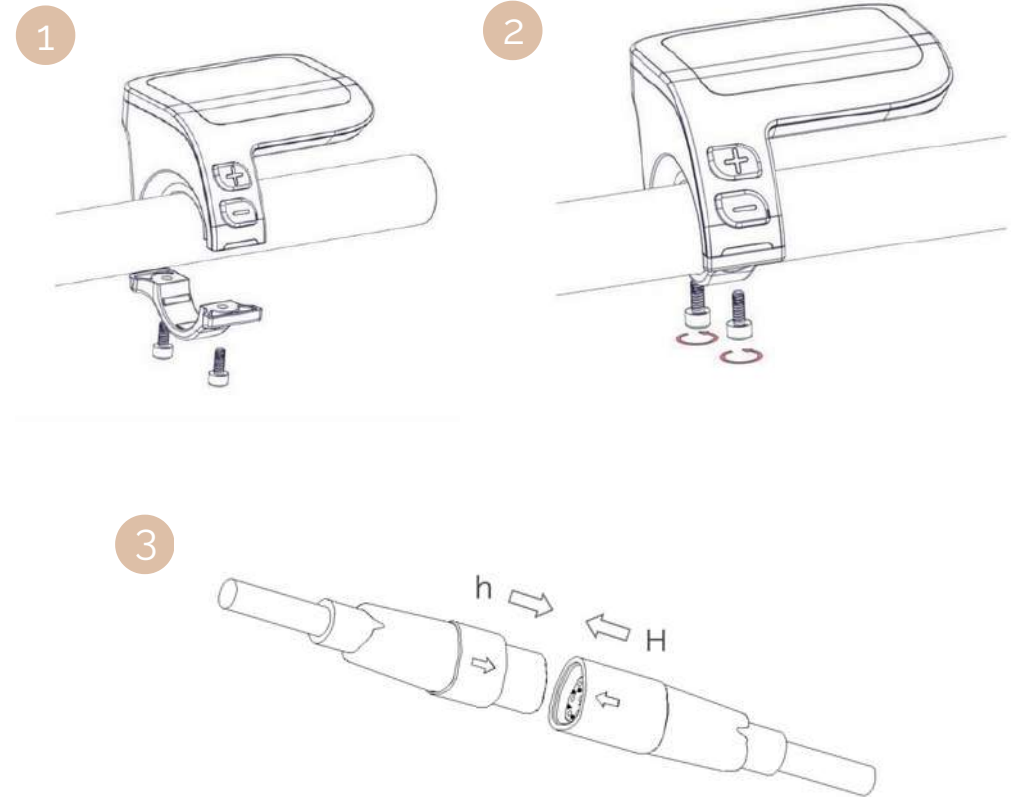

CHAPTER 2

Display

- 1)** Display of battery capacity in real time
- 2)** Support level
- 3)** The display shows this symbol when the lights are turned on.
- 4)** Unit of speed
- 5)** Digital speed display
- 6)** Trip: Daily kilometers (TRIP) - Total kilometers (ODO) - Top speed (MAX) Average speed (AVG) - Remaining distance (RANGE) - Energy Consumption (CALORIES) - Output power (POWER)- Travel time (TIME).

IMAGES

Chapter 2



CHAPTER 3

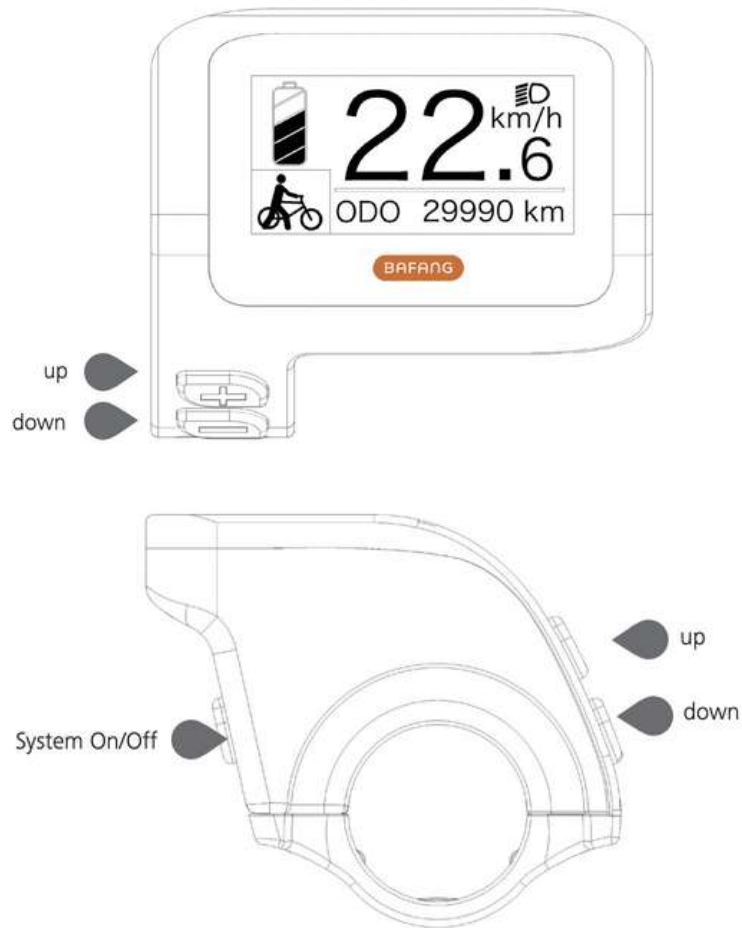

Key Definition



CHAPTER 4

Normal operation

4. Switching the System ON/OFF.

Press and hold  (>2S) on the display to **turn on** the system.
Press and hold  (>2S) again to **turn off** the system.

If the "automatic shutdown time" is set to **5 minutes** (it can be reset with the "Auto Off" function, See "**Auto Off**"), the display will **automatically be turned off** within the desired time when it is not in operation. If the password function is enabled, you must **enter** the correct password to use the system.



CHAPTER 4

Normal operation

4.1 Selection of Support Levels

When the display is **turned on**, press the (+) or (-) button (<0.5S) to switch to the support level, the lowest level is 0, the highest level is 5.

When the system is switched on, the support level starts in **level 1**. There is no support at level 0. For different assist levels please see part "**Assist Mode**".



CHAPTER 4

Normal operation

4.2 Selection mode

Briefly press the button  (<0.5s) to see the **different trip modes**.

Trip: daily kilometers (TRIP) - total kilometers (ODO) - Maximum speed (MAX) - Average speed (AVG) - Remaining distance (RANGE) - Energy consumption (CALORIES) - Output power (POWER) - Travel time (TIME).

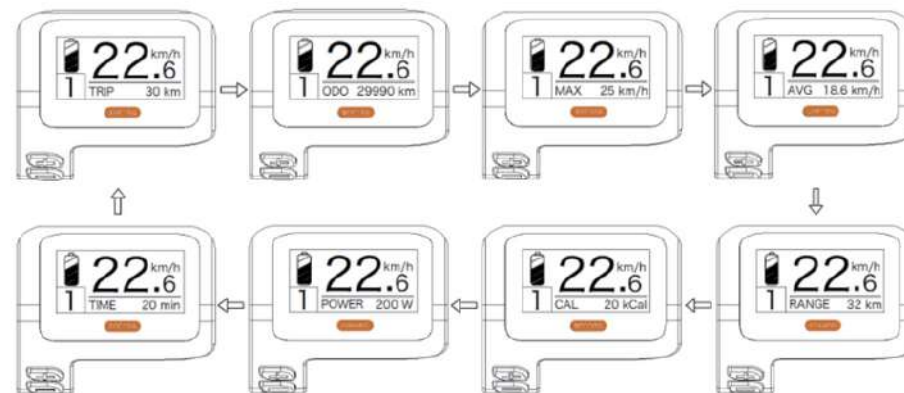

CHAPTER 4

Normal operation

4.3 Headlights / backlighting

Hold the button (+) (>2S) to activate the headlight and taillights.

Hold the button (+) (>2S) again to turn off the headlight.

The brightness of the backlight can be set in the display settings "**Brightness**".

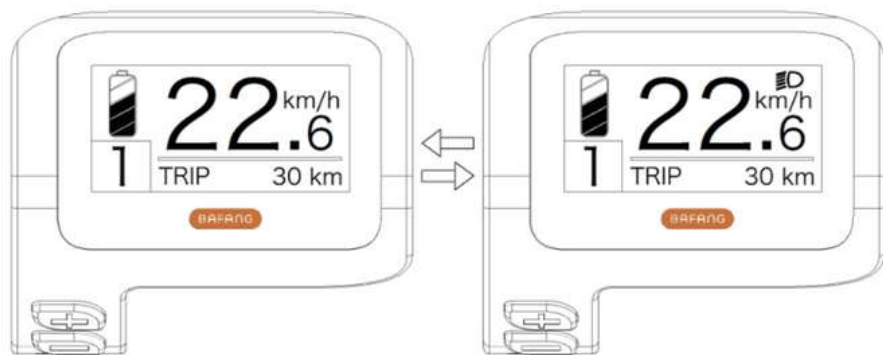



CHAPTER 4

Normal operation

4.4 Walk Assistance

The Walk assistance can only be activated with a standing pedelec.

Activation: Press the button (-) until this symbol  appears. Next press and hold down the (-) button whilst  the symbol is displayed, now the **walk assistance** will activate.

The symbol  will blink and the pedelec moves approx. 5 km/h. After releasing the (-) button, the motor stops automatically and switches back to **level 0**.

The Walk assistance can only be activated with a standing pedelec.



CHAPTER 4

Normal operation

4.5 Service

The display shows **"SERVICE"** as soon as a certain number of kilometers or battery charges has been reached. With a mileage of more than **5000 km** (or 100 charge cycles), the **"SERVICE"** function is **displayed** on the display. Every 5000 km the display "SERVICE" is displayed every time. This function can be set in the display settings.

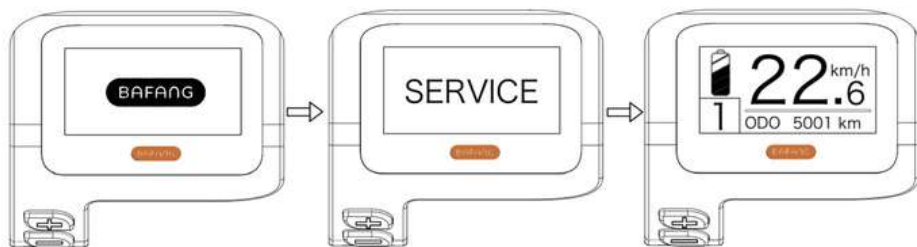

CHAPTER 4

Normal operation

4.6 Battery capacity indicator

The battery capacity is shown in the **top left** of the display. Each full bar represents a remaining capacity of the battery in a **percentage** (as shown in the diagram below):



Capacity Range	Indicator
80%-100%	
60%-80%	
40%-60%	
20%-40%	
5%-20%	
<5%	blinking

CHAPTER 5

Settings

After the display is **turned on**, press and hold the **(+)** and **(-)** buttons (at the same time) to enter into the setting menu. By pressing the **(+)** or **(-)** button (<0.5S), you can highlight and select **Display Setting**, **Information** or **Exit**.

Then press the  button (<0.5S) to confirm your selected option.

Or highlight **"EXIT"** and press the  button (<0.5S) to return to the main menu, or highlight **"BACK"** and press (<0.5S) the  button (<0.5S) to return to the **Settings** interface.



CHAPTER 5

Settings

5. Display Setting

Press the **(+)** or **(-)** button (<0.5S) and highlight **Display Setting**, and then briefly press the button  (<0.5S) to access the following selections.

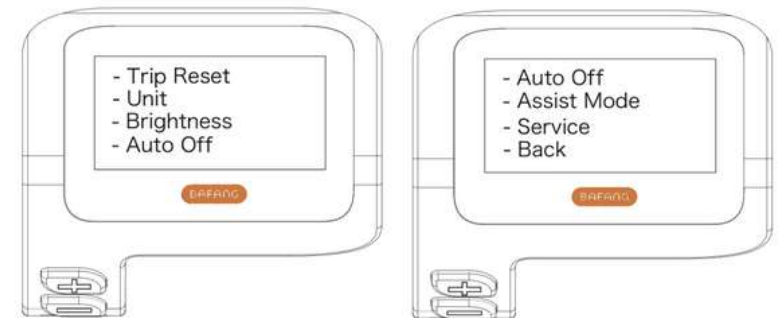

CHAPTER 5

Settings

5.1.1 "TRIP Reset" Reset mileage

Press the **(+)** or **(-)** button (<0.5S) to highlight **"Trip Reset"** in the Display setting menu, and then press  button (<0.5S) to select. Then with the **(+)** or **(-)** button choose between **"YES"** or **"NO"**.

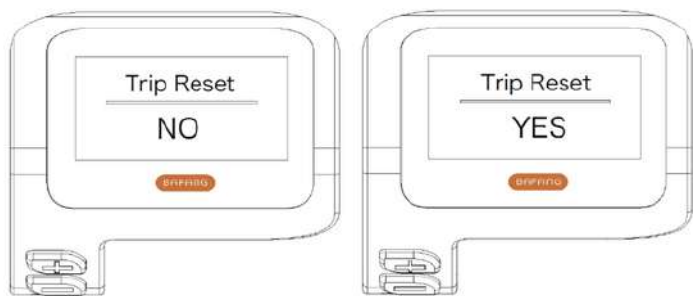

Once you have chosen your desired selection, press the  button (<0.5S) to save and exit to the **"Display setting"**.



CHAPTER 5

Settings

5.1.2 "Unit" Selections in km/Miles

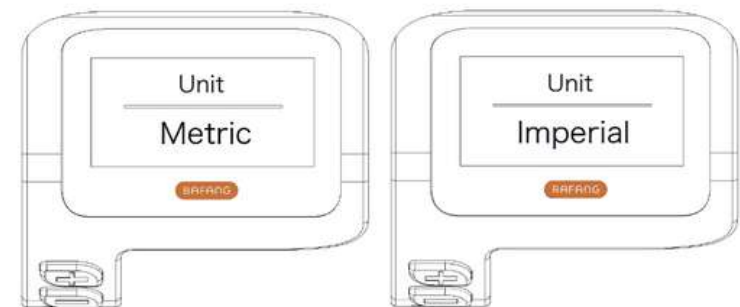

Press the **(+)** or **(-)** button (<0.5S) to highlight **"Unit"** in the Display setting menu, and then press  button (<0.5S) to select. Then with the **(+)** or **(-)** button choose between **"Metric"** (kilometer) or **"Imperial"** (Miles). Once you have chosen your desired selection, press the  button (<0.5S) to save and exit to the "Display setting".



CHAPTER 5

Settings

5.1.3 "Brightness" Display brightness

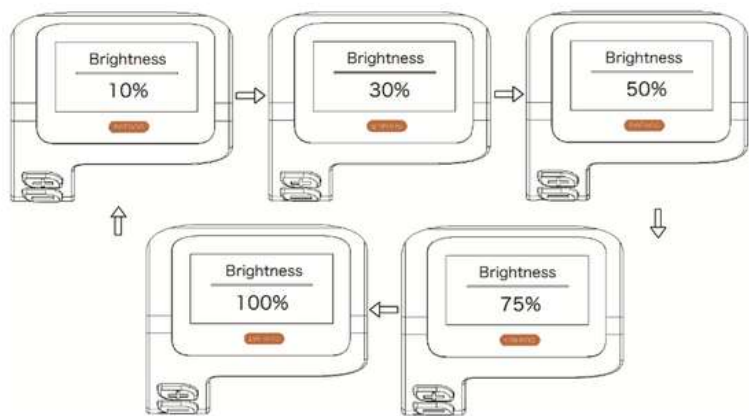

Press the (+) or (-) button (<0.5S) to highlight "Brightness" in the Display setting menu, and then press  button (<0.5S) to select. Then with the (+) or (-) button choose between "100%" / "75%" / "50%" / "30%" / "10%". Once you have chosen your desired selection, press the  button (<0.5S) to save and exit to the "Display setting".



CHAPTER 5

Settings

5.1.4 "Auto Off" Set Automatic system switch off time

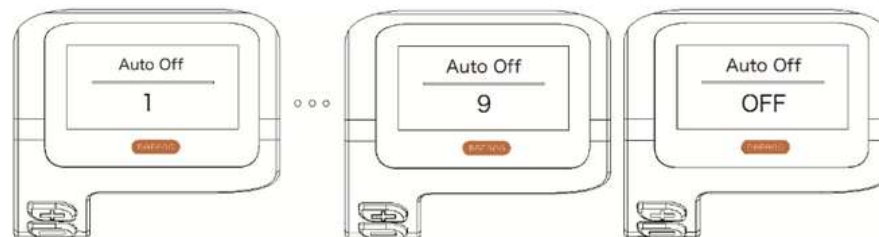

Press the (+) or (-) button (<0.5S) to highlight "Auto Off" in the Display setting menu, and then press  button (<0.5S) to select. Then with the (+) or (-) button choose "OFF", "9"/"8"/"7"/"6"/"5"/"4"/"3"/"2"/"1", (The numbers are measured in **minutes**). Once you have chosen your desired selection, press the  button (<0.5S) to save and exit to the "Display setting".



CHAPTER 5

Settings

5.1.5 "Assist Mode" Set support level

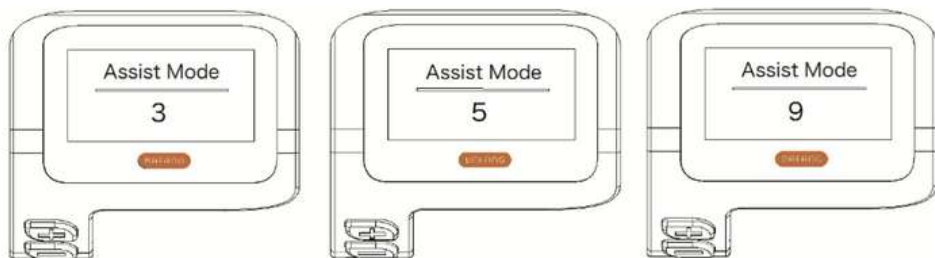

Press the **(+)** or **(-)** button (<0.5S) to highlight **"Max Pass"** in the Display setting menu, and then press  button (<0.5S) to select. Then with the **(+)** or **(-)** button choose between "3/5/9" (the amount of support levels). Once you have chosen your desired selection, press the  button (<0.5S) to save and exit to the "Display setting".



CHAPTER 5

Settings

5.1.6 "Service" Switching the notification on and off

Press the **(+)** or **(-)** button (<0.5S) to highlight **"Service"** in the Display setting menu, and then press  button (<0.5S) to select. Then with the **(+)** or **(-)** button between **"NO"** or **"YES"**. Once you have chosen your desired selection, press the  button (<0.5S) to save and exit to the "Display setting".

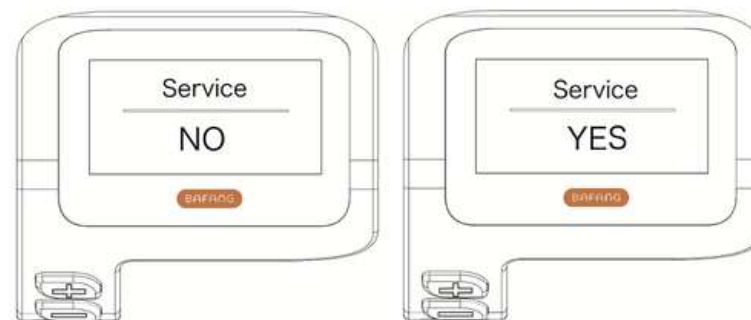

CHAPTER 5

Settings

5.2 Information

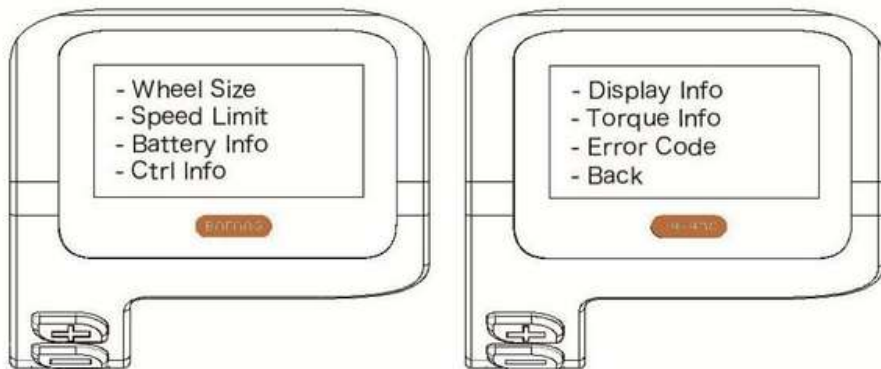

Once the display is turned on, press and hold the (+) and (-) buttons (at the same time) to enter into the setting menu, press the (+) or (-) button (<0.5S) to select "Information", then press the  button (<0.5S) to confirm and enter into "Information".



CHAPTER 5

Settings

5.2.1 Wheel Size

Press the (+) or (-) button (<0.5S) to highlight "Wheel Size" then press the  button (<0.5S) to confirm and view the wheel size. To return, press the  button (<0.5S) to exit back to the "Information".



This information cannot be changed, this is only for information, about the pedelec.



CHAPTER 5

Settings

5.2.2 Speed Limit

Press the (+) or (-) button (<0.5S) to highlight "Speed Limit" then press the  button (<0.5S) to confirm and view the speed limit. To return, press the  button (<0.5S) to exit back to the "Information".

This information **cannot be changed**, this is only for information, about the pedelec.



CHAPTER 5

Settings

5.2.3 Battery Information

Press the (+) or (-) button (<0.5S) to highlight "Battery Info" then press the  button (<0.5S) to confirm. Now press the (+) or (-) button (<0.5S) to view the contents.

To return, press the  button (<0.5S) to exit back to the "Information".



Code	Code definition	unit	Code	Code definition	unit
Hardware ver	Hardware version		b10	Absolute SOC	%
Hardware ver	Software version		b11	Cycle	times
b01	Current temperature	°C	b12	Maximum not charging time	Hour
b04	Total voltage	mV	b13	Recently not charging time	Hour
b06	Average current	mA	d00	Number of battery cell	
b07	Remaining capacity	mAh	d01	Voltage of cell 1	mV
b08	Full charge capacity	mAh	d02	Voltage of cell 2	mV
b09	Relative SOC	%	dn	Voltage of cell n	mV

NOTE: If no data is detected, "--" is displayed.

CHAPTER 5

Settings

5.2.4 Controller Information



Press the **(+)** or **(-)** button (<0.5S) to highlight **"Ctrl Info"** then press the  button (<0.5S) to confirm. Now press the **(+)** or **(-)** button (<0.5S) to view **Hardware Version** or **Software Version**. To return, press the  button (<0.5S) to exit back to the "Information".



CHAPTER 5

Settings

5.2.5 Display Information



Press the **(+)** or **(-)** button (<0.5S) to highlight **"Display Info"** then press the  button (<0.5S) to confirm. Now press the **(+)** or **(-)** button (<0.5S) to view to view **Hardware Version** or **Software Version**. To return, press the  button (<0.5S) to exit back to the "Information".



CHAPTER 5

Settings

5.2.6 Torque Information



Press the **(+)** or **(-)** button (<0.5S) to highlight **"Torque Info"** then press the  button (<0.5S) to confirm. Now press the **(+)** or **(-)** button (<0.5S) to view **Hardware Version** or **Software Version**. To return, press the  button (<0.5S) to exit back to the "Information".



CHAPTER 5

Settings

5.2.7 Error Code

Press the **(+)** or **(-)** button (<0.5S) to highlight **"Error code"** then press the  button (<0.5S) to confirm. Now press the **(+)** or **(-)** button (<0.5S) to view a list of error codes from the pedelec. It can show information for the last ten errors of the pedelec. The error code **"00"** means that there is **no error**. To return, press the  button (<0.5S) to exit back to the "Information".

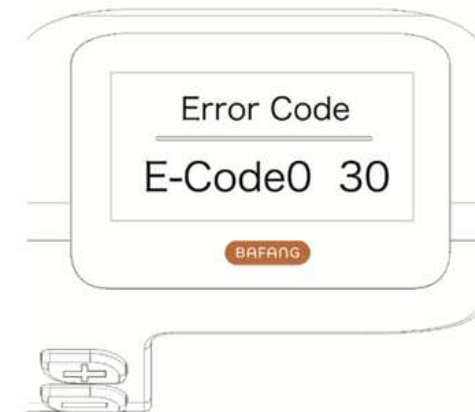

CHAPTER 6

Error Code Definition

The HMI can show the faults of Pedelec. When a fault is detected, one of the following error codes will be indicated too.

NOTE: Please read carefully the description of the error code. When the error code appears, please first restart the system. If the problem is not eliminated, please contact your dealer or technical personnel.

CHAPTER 6

Error Code Definition

Error	Declaration	Troubleshooting
04	The throttle is not back in its correct position.	Check the connector from the throttle is correctly connected. If this does not solve the problem, please change the throttle.
05	The throttle has fault.	<ol style="list-style-type: none">1. Check the connector and cable of the throttle are not damaged and correctly connected.2. Disconnect and reconnect the throttle, if still no function please change the throttle.
07	Overvoltage protection	<ol style="list-style-type: none">1. Remove and re-Insert the battery to see if it resolves the problem.2. Using the BESST tool update the controller.3. Change the battery to resolve the problem.
08	Error with the hall sensor signal inside the motor	<ol style="list-style-type: none">1. Check all connectors from the motor are correctly connected.2. If the problem still occurs, please change the motor.
09	Error with the Engine phase's	Please change the motor.
10	The temperature inside the engine has reached its maximum protection value	<ol style="list-style-type: none">1. Turn off the system and allow the Pedelec to cool down.2. If the problem still occurs, please change the motor.

CHAPTER 6

Error Code Definition

11	The temperature sensor inside the motor has an error	Please change the motor.
12	Error with the current sensor in the controller	Please change the controller or contact your supplier.
13	Error with the temperature sensor inside of the battery	<ol style="list-style-type: none">1. Check all connectors from the battery are correctly connected to the motor.2. If the problem still occurs, please change the Battery.
14	The protection temperature inside the controller has reached its maximum protection value	<ol style="list-style-type: none">1. Allow the pedelec to cool down and restart the system.2. If the problem still occurs, please change the controller or contact your supplier.
15	Error with the temperature sensor inside the controller	<ol style="list-style-type: none">1. Allow the pedelec to cool down and restart the system.2. If the problem still occurs, Please change the controller or contact your supplier.

CHAPTER 6

Error Code Definition

21	Speed sensor Error	<ol style="list-style-type: none">1. Restart the system2. Check that the magnet attached to the spoke is aligned with the speed sensor and that the distance is between 10 mm and 20 mm.3. Check that the speed sensor connector is connected correctly.4. Connect the pedelec to BESST, to see if there is a signal from the speed sensor.5. Using the BESST Tool- update the controller to see if it resolves the problem.6. Change the speed sensor to see if this eliminates the problem. If the problem still occurs, please change the controller or contact your supplier.
25	Torque signal Error	<ol style="list-style-type: none">1. Check that all connections are connected correctly.2. Please connect the pedelec to the BESST system to see if torque can be read by the BESST tool.3. Using the BESST Tool update the controller to see if it resolves the problem, if not please change the torque sensor or contact your supplier.

CHAPTER 6

Error Code Definition

26	Speed signal of the torque sensor has an error	<ol style="list-style-type: none">1. Check that all connections are connected correctly.2. Please connect the pedelec to the BESST system to see if speed signal can be read by the BESST tool.3. Change the Display to see if the problem is solved.4. Using the BESST Tool update the controller to see if it resolves the problem, if not please change the torque sensor or contact your supplier.
27	Overcurrent from controller	Using the BESST tool update the controller. If the problem still occurs, please change the controller or contact your supplier.
30	Communication problem	<ol style="list-style-type: none">1. Check all connections on the pedelec are correctly connected.2. Using the BESST Tool run a diagnostics test, to see if it can pinpoint the problem.3. Change the display to see if the problem is solved.4. Change the EB-BUS cable to see if it resolves the problem.5. Using the BESST tool, re-update the controller software. If the problem still occurs please change the controller or contact your supplier.

CHAPTER 6

Error Code Definition

33	Brake signal has an error (If brake sensors are fitted)	<ol style="list-style-type: none">1. Check all connectors are correctly connected on the brakes.2. Change the brakes to see if the problem is solved. If problem continues Please change the controller or contact your supplier.
35	Detection circuit for 15V has an error	Using the BESST tool update the controller to see if this resolves the problem. If not, please change the controller or contact your supplier.
36	Detection circuit on the keypad has an error	Using the BESST tool update the controller to see if this resolves the problem. If not, please change the controller or contact your supplier.
37	WDT circuit is faulty	Using the BESST tool update the controller to see if this resolves the problem. If not, please change the controller or contact your supplier.
41	Total voltage from the battery is too high	Please change the battery.
42	Total voltage from the battery is too low	Please Charge the battery. If the problem still occurs, please change the battery.

CHAPTER 6

Error Code Definition

43	Total power from the battery cells is too high	Please change the battery.
44	Voltage of the single cell is too high	Please change the battery.
45	Temperature from the battery is too high	Please let the pedelec cool down. If problem still occurs, please change the battery.
46	The temperature of the battery is too low	Please bring the battery to room temperature. If the problem still occurs, please change the battery.
47	SOC of the battery is too high	Please change the battery.
48	SOC of the battery is too low	Please change the battery.
61	Switching detection defect	1. Check the gear shifter is not jammed. 2. Please change the gear shifter.
62	Electronic derailleur cannot release.	Please change the derailleur.
71	Electronic lock is jammed	1. Using the BESST tool update the Display to see if it resolves the problem. 2. Change the display if the problem still occurs, please change the electronic lock.
81	Bluetooth module has an error	Using the BESST tool, re-update the software onto the display to see if it resolves the problem. If not, Please change the display.

CHAPTER 7

General information

- If the **error** information from the display cannot be corrected according to the instructions, please **contact your retailer**.
- The product is designed to be **waterproof**.
- It is highly recommended to **avoid** submerging the display **under water**.
- Do **not** clean the display with a **steam jet**, **high-pressure cleaner** or **water hose**.
- Please use this product with **care**.
- Do **not** use **thinners** or **other solvents** to clean the display. Such substances can damage the surfaces.
- **Warranty is not included** due to **wear** and **normal use** and aging.



MANUAL LEKKER BIKES



BAFANG DISPLAY



@lekkerbikes



@LEKKERbikes



www.lekkerbikes.com